

"PUBLIC III" PAY-WINDOW INTERCOM

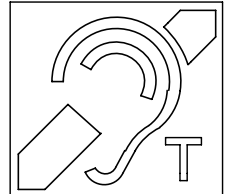

Induction Loop
installed for
Hearing Aids

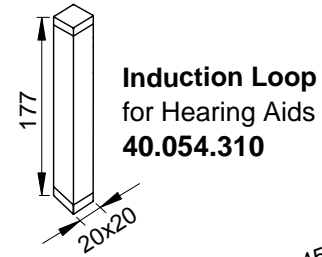

Induction Loop
for Hearing Aids
40.054.310

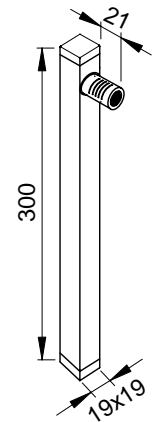

M2/T Public Side
Microphone ®
Water & Vandal Resistant
40.005.022

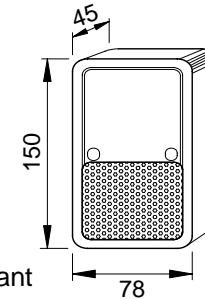

L2 Public Side
Loudspeaker
40.006.112

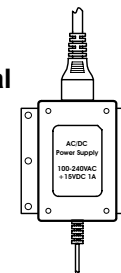

External
AC/DC
Power
Supply
100-240VAC
+15VDC 1A
40.054.300

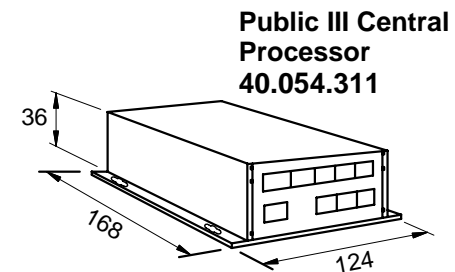

Public III Central
Processor
40.054.311

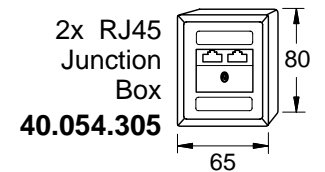

2x RJ45
Junction
Box
40.054.305

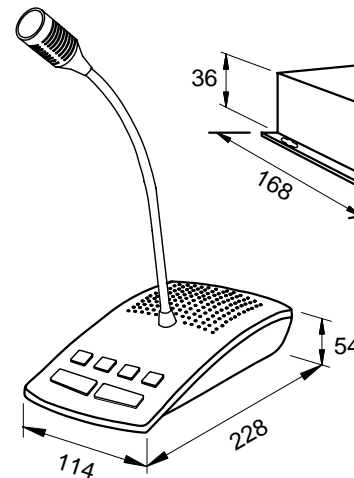

Public III
Operator's
Mic/Loudspeaker
Unit
40.054.301

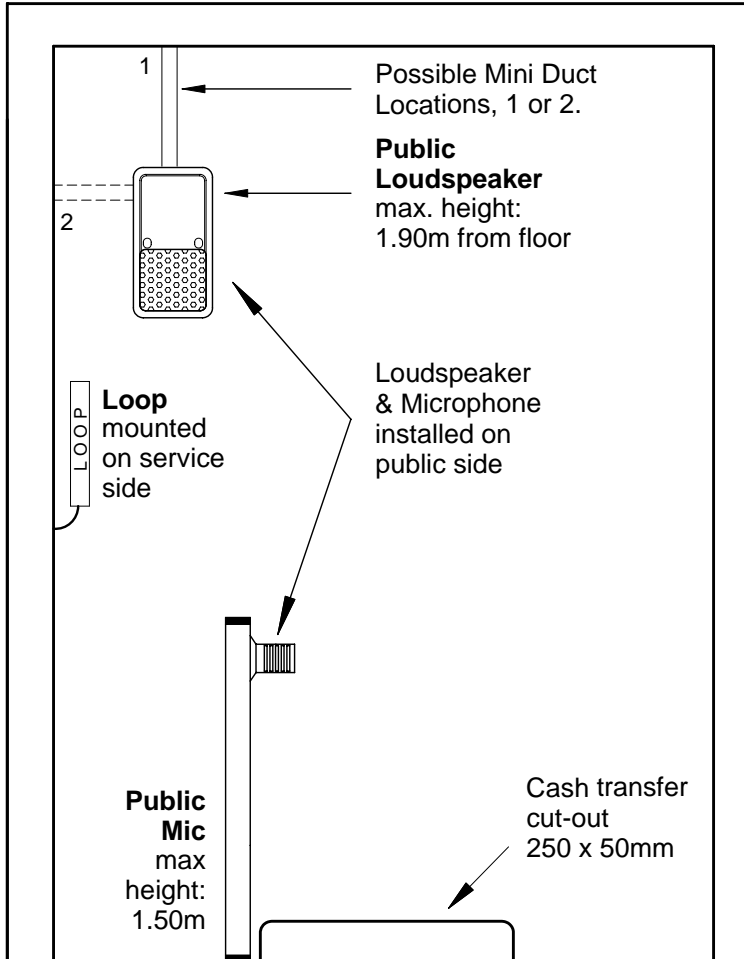

Specifications:

Power Supply: 100-240VAC 50Hz
+15VDC 1A

Power Consumption: approx. 20VA

JOB NO.:	DWG NO.:	TITLE:	CLARSON "Public III" Voice Loop System for bullet proof counters Standard Australian Configuration 40.054.306
DATE:	SCALE:	CLIENT:	
DWN: NMI	SIZE: A4	COPYRIGHT:	The drawing remains the property of Hertz Electronics Pty Ltd and may not be used, copied, or reproduced, in whole or part in any form without written permission.
539 GLENMORE ROAD, EDGECLIFF NSW 2027 PH: -61-2-9363 3029 FAX: -61-2-9327 7827 email address: sales@hertzelectronics.com.au hertz web site: www.hertzelectronics.com.au		Hertz Electronics Pty Ltd A.B.N. 24 002 885 967	